

AL796

MagnetoResistive FixPitch Sensor (2 mm)

The AL796 is an Anisotropic MagnetoResistive (AMR) position sensor. The sensor contains two Wheatstone bridges shifted against each other. The output signals are proportional to sine and cosine of the coordinate to be measured (see Fig. 1).

The MR strips of this FixPitch sensor geometrically match to a pole length of 2 mm (equal to a magnetic period of 4 mm). Additionally, the sensor layout incorporates PerfectWave technology, i. e. the position of each block of MR strips has a special arrangement to filter higher harmonics and to increase the signal quality. The resistors in this FixPitch sensor are distributed over several poles (2), thus the errors in the magnetic measurement scale are reduced without any signal delay. The amplitude is almost constant in a wide working range between sensor and magnetic scale. The bond version of AL796 is available as bare die. For SMD processing, the sensor is available in a SiL6, LGA or SiL8 package.

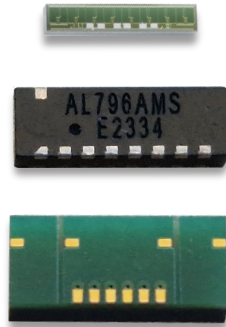

Product Overview of AL796

Article description	Package	Delivery Type
AL796ACA-AB ¹⁾	Die on Wafer	Waferbox
AL796ACA-AC	Bare Die	Waffle pack (192 pcs)
AL796AKA-AC	SiL6	Waffle pack (90 pcs)
AL796AMA-AE	LGA6L	Tape on reel (2000 pcs)
AL796AMS-AE	SiL8	Tape on reel (2000 pcs)
AL796AMS-AS	SiL8-D	Tape on reel (2000 pcs)
AL796 Evalboard	Evalboard	ESD-Box

¹⁾ minimum order quantities apply.

Quick Reference Guide

Symbol	Parameter	min.	typ.	max.	Unit
P	Pitch (magnetic pole length)	-	2.0	-	mm
V _{CC}	Supply voltage	-	5.0	-	V
V _{off}	Offset voltage per V _{CC}	-2.0	-	+2.0	mV/V
V _{peak}	Signal amplitude per V _{CC}	9.0	11.0	13.0	mV/V
R _B	Bridge resistance	2.2	3.4	4.6	kΩ

Absolute Maximum Ratings

In accordance with the absolute maximum rating system (IEC60134).

Symbol	Parameter	Min.	Max.	Unit
V _{CC}	Supply voltage	-9.0	+9.0	V
T _{amb}	Ambient temperature	-40	+125	°C
T _{stg(Die)}	Storage temperature (Die)	-65	+150	°C
T _{stg(others)}	Storage temperature (others)	-40	+125	°C

Stresses beyond those listed under "Absolute maximum ratings" may cause permanent damage to the device.

This is a stress rating only and functional operation of the device at these or any other conditions beyond those indicated in the operational sections of this specification is not implied. Exposure to absolute maximum rating conditions for extended periods may affect device reliability.

Features

- Based on the Anisotropic MagnetoResistive (AMR) effect
- Contains two wheatstone bridges on Chip
- Sine and Cosine output
- Adapted to 2 mm poles
- PurePitch design (2 poles)
- PerfectWave technology
- Ambient temperature range from -40 °C to +125 °C

Advantages

- Contactless angle and position measurement
- Large air gap
- Excellent accuracy
- Minimized offset voltage
- Negligible hysteresis

Applications

Incremental or absolute encoder for linear or rotary movements in various industrial applications, such as:

- Motor integrated encoder
- Motorfeedback system
- Linear guide



Magnetic Data

Symbol	Parameter	Conditions	min.	typ.	max.	Unit
H _{ext}	Magnetic field strength ¹⁾		5.0	25.0	-	kA/m

¹⁾ The stimulating magnetic field in the sensor plane to ensure minimum error specified in note 8.

Electrical Data

T_{amb} = +25°C, H_{ext} = 25 kA/m; V_{CC} = 5.0 V; unless otherwise specified.

Symbol	Parameter	Conditions	min.	typ.	max.	Unit
V _{CC}	Supply voltage		-	5.0	-	V
V _{off}	Offset voltage per V _{CC}	See Fig. 2	-2.0	-	+2.0	mV/V
TC _{Voff}	Temperature coefficient of V _{off} ²⁾	T _{amb} = (-40...+125)°C	-4.0	-	+4.0	(μV/V)/K
V _{peak}	Signal amplitude per V _{CC} ³⁾	See Fig. 2	9.0	11.0	13.0	mV/V
TC _{Vpeak}	Temperature coefficient of V _{peak} ⁴⁾	T _{amb} = (-40...+125)°C	-0.48	-0.42	-0.36	%/K
R _B	Bridge resistance ⁵⁾		2.2	3.4	4.6	kΩ
R _S	Sensor resistance ⁶⁾		1.1	1.7	2.3	kΩ
TC _{RB}	Temperature coefficient of R _B ⁷⁾	T _{amb} = (-40...+125)°C	0.24	0.28	0.32	%/K
FIT	FIT-Rate		-	0.9	-	x10 ⁹ h
MTTF	Mean time to failure	At 55 °C	-	126839	-	years

²⁾ $TC_{Voff} = 100 \cdot \frac{V_{off}(T_2) - V_{off}(T_1)}{T_2 - T_1}$ with T₁ = +25°C; T₂ = +125°C.

³⁾ Maximal output voltage without offset influences. Periodicity of V_{peak} is sin(P) and cos(P).

⁴⁾ $TC_{Vpeak} = 100 \cdot \frac{V_{peak}(T_2) - V_{peak}(T_1)}{V_{peak}(T_{amb}) \cdot (T_2 - T_1)}$ with T₁ = +25°C; T₂ = +125°C.

⁵⁾ Bridge resistance between +V_{O1} and -V_{O1}, +V_{O2} and -V_{O2}.

⁶⁾ Sensor resistance between V_{CC} and GND.

⁷⁾ $TC_{RB} = 100 \cdot \frac{R_B(T_2) - R_B(T_1)}{R_B(T_{amb}) \cdot (T_2 - T_1)}$ with T₁ = +25°C; T₂ = +125°C.

Accuracy

T_{amb} = +25°C, H_{ext} = 25 kA/m; V_{CC} = 5.0 V; unless otherwise specified.

Symbol	Parameter	Conditions	min.	typ.	max.	Unit
ΔX	Measurement error ⁸⁾		-	5.0	7.0	μm
k	Amplitude synchronism ⁹⁾		-	0.1	1	% of V _{peak}

⁸⁾ ΔX = |X_{real} - X_{measured}| without offset influences due deviations from ideal sinusoidal characteristics (ascertained at an ideal magnetic scale).

⁹⁾ $k = 100 - 100 \cdot \frac{V_{Peak1}}{V_{Peak2}}$

Dynamic Data

Symbol	Parameter	Conditions	min.	typ.	max.	Unit
f	Frequency range		1.0 ¹⁰⁾	-	-	MHz

¹⁰⁾ No significant amplitude loss in this frequency range.

General Data

Symbol	Parameter	Conditions	min.	typ.	max.	Unit
P	Pitch (magnetic pole length)	See Fig. 1	-	2.0	-	mm
d	Distance ¹¹⁾		-	0.7	-	mm
T _{amb}	Ambient temperature		-40	-	+125	°C

¹¹⁾ See Fig. 3 for detailed information.

Output Signal Information

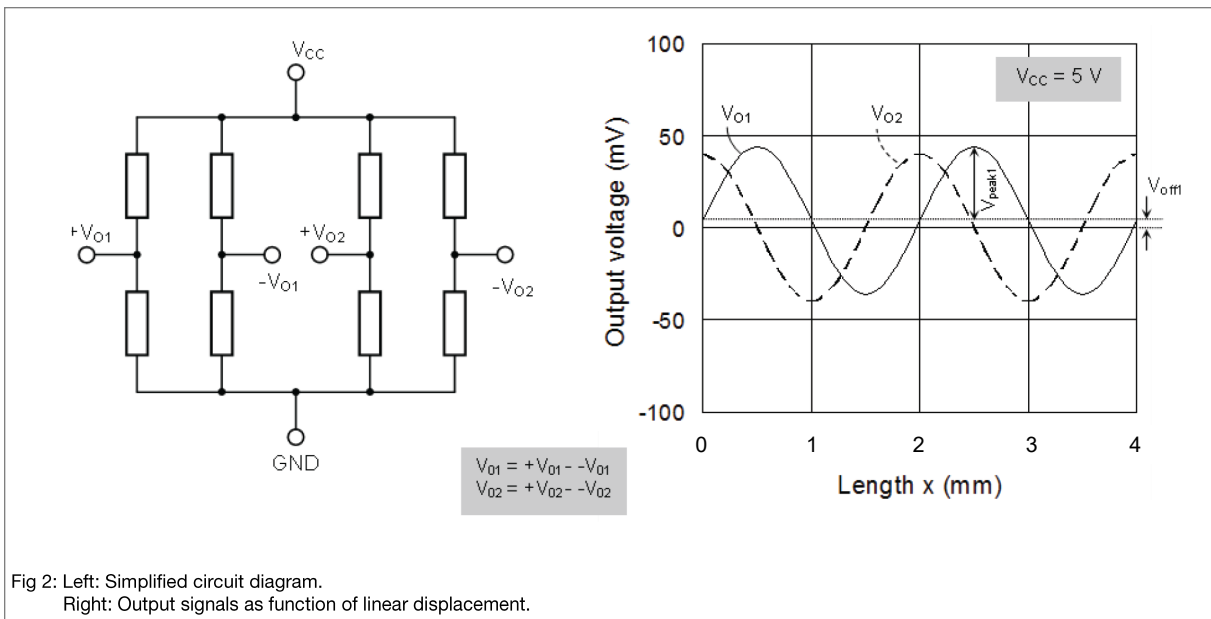
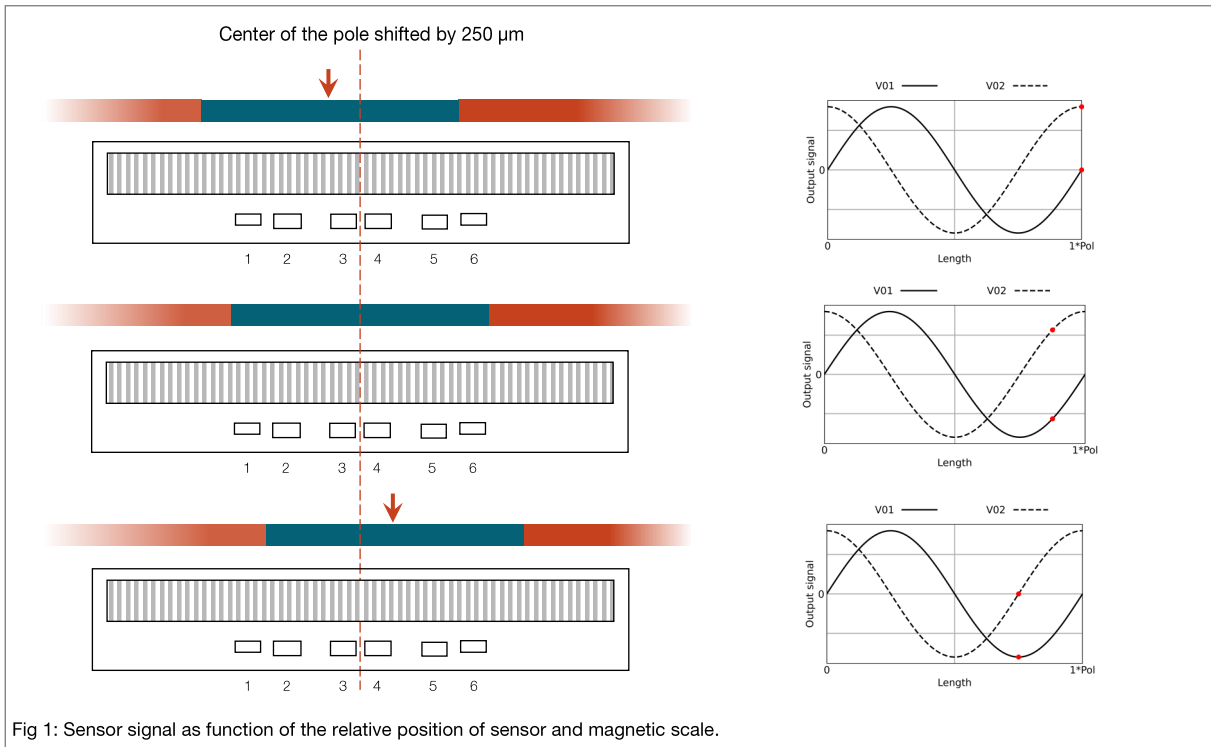

Typical Performance Graphs

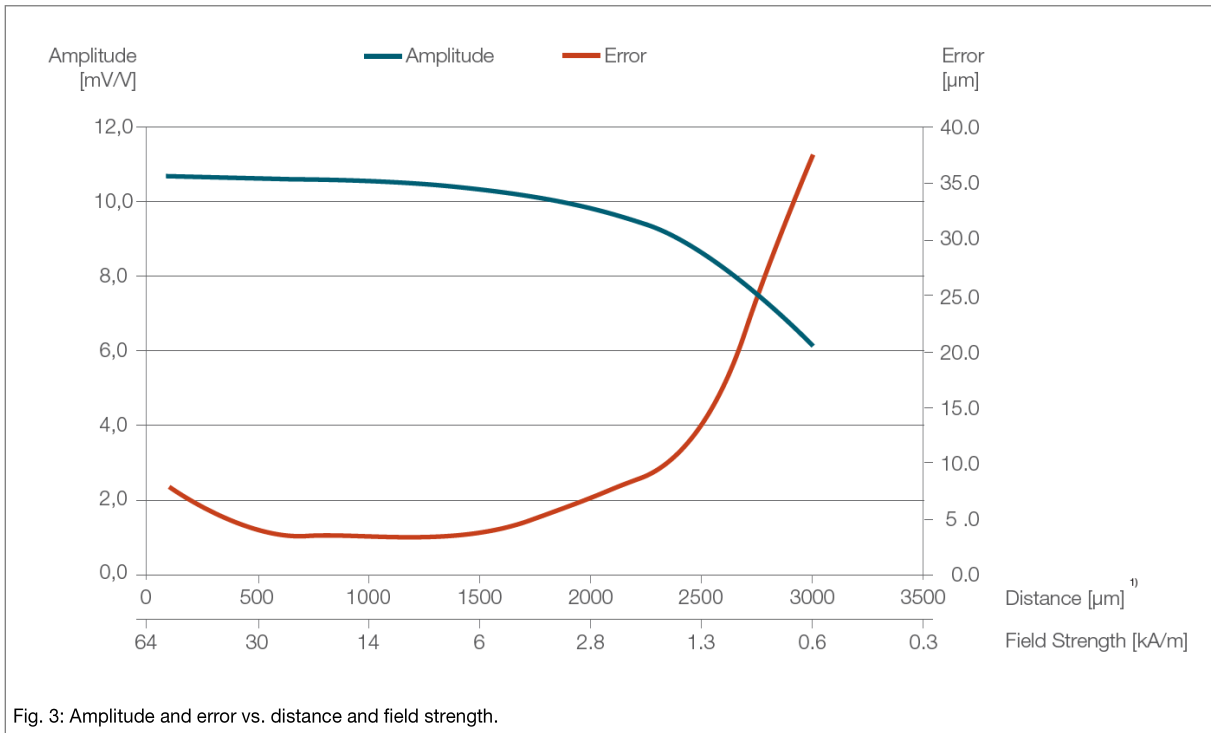

Fig. 3: Amplitude and error vs. distance and field strength.

¹⁾ In use with a plastic bounded hard ferrite magnetic scale (Br = 220 mT, thickness 1 mm, mounted on stainless steel),

AL796ACA Bare Die

Pinout

Pad	Symbol	Parameter
1	+V _{O1}	Positive output voltage bridge 1
2	+V _{O2}	Positive output voltage bridge 2
3	V _{CC}	Supply voltage
4	GND	Ground
5	-V _{O1}	Negative output voltage bridge 1
6	-V _{O2}	Negative output voltage bridge 2

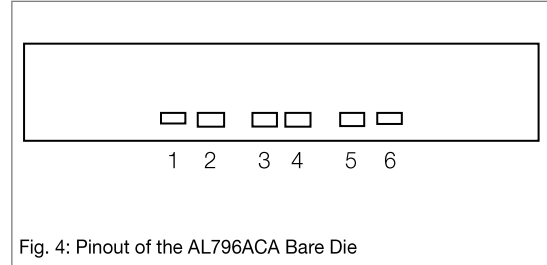

Fig. 4: Pinout of the AL796ACA Bare Die

Dimensions

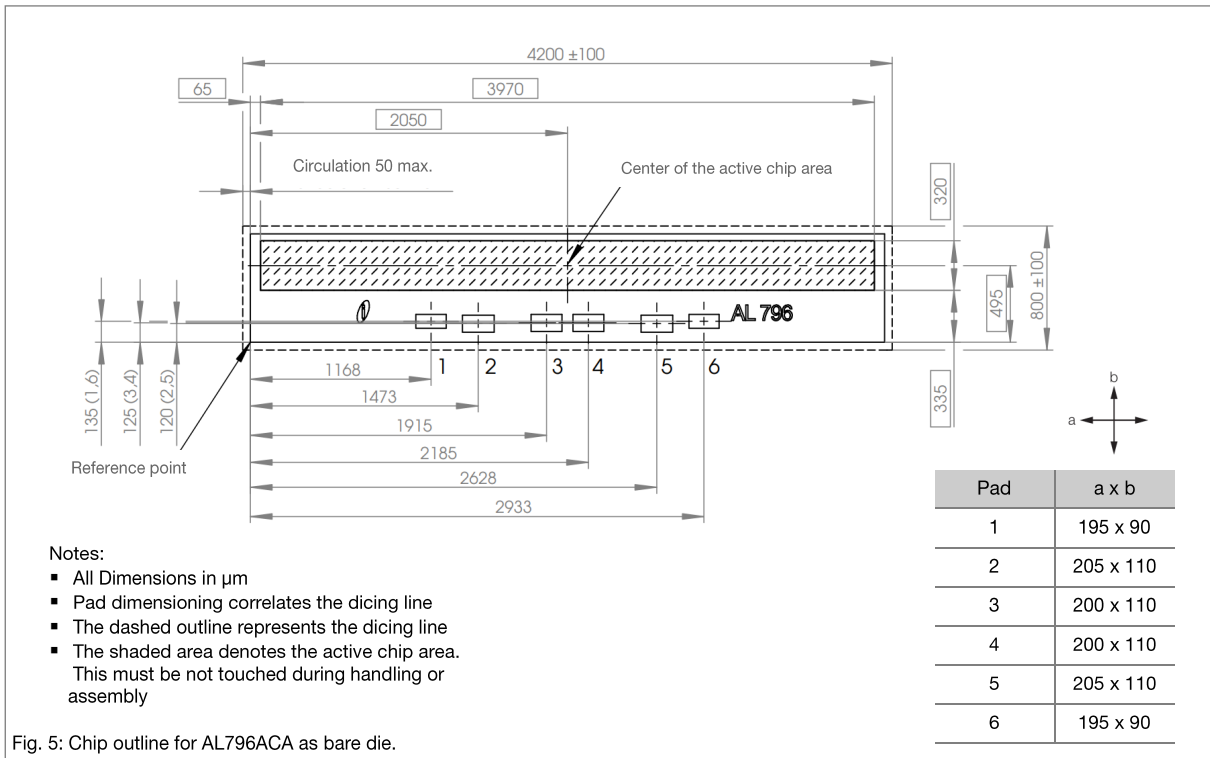

Fig. 5: Chip outline for AL796ACA as bare die.

Data for Packaging and Interconnection Technologies

Parameter	Value	Unit
Chip area ¹⁾	4.2 x 0.8	mm ²
Chip thickness	525 ± 40	μm
Pad size	See Fig. 5	-
Pad thickness	0.8	μm
Pad material	AlCu	-

¹⁾ Tolerances of chip see Fig. 5.

AL796AKA SIL6 Package

Pinout

Pad	Symbol	Parameter
1	+V _{O1}	Positive output voltage bridge 1
2	+V _{O2}	Positive output voltage bridge 2
3	V _{CC}	Supply voltage
4	GND	Ground
5	-V _{O1}	Negative output voltage bridge 1
6	-V _{O2}	Negative output voltage bridge 2

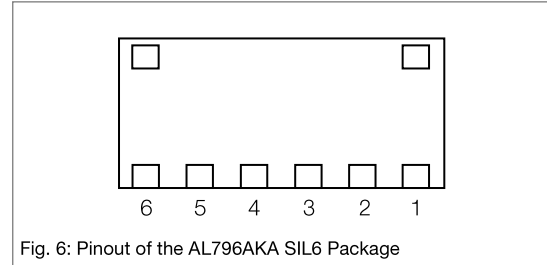

Fig. 6: Pinout of the AL796AKA SIL6 Package

Dimensions

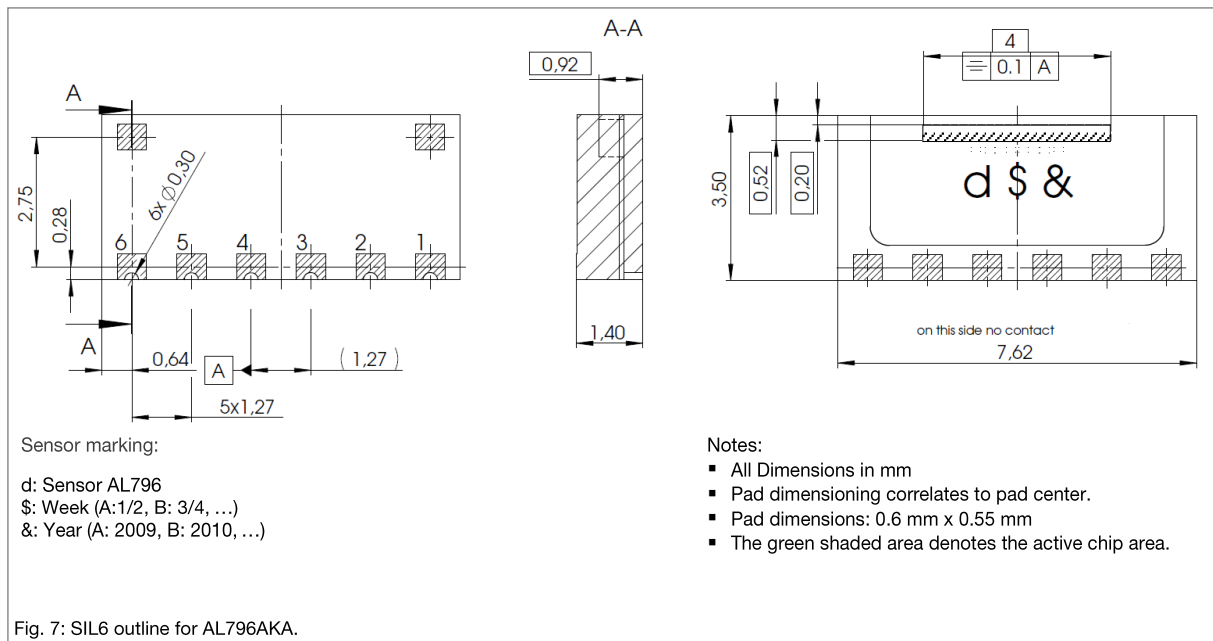

Fig. 7: SIL6 outline for AL796AKA.

AL796AMA LGA6L Package

Pinout

Pad	Symbol	Parameter
1	+V _{O1}	Positive output voltage bridge 1
2	+V _{O2}	Positive output voltage bridge 2
3	GND	Ground
4	V _{CC}	Supply voltage
5	-V _{O1}	Negative output voltage bridge 1
6	-V _{O2}	Negative output voltage bridge 2
7-10	NC	Not connected

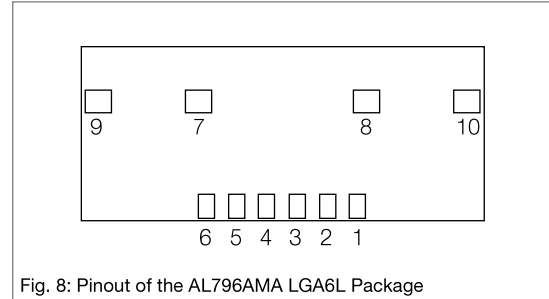

Fig. 8: Pinout of the AL796AMA LGA6L Package

Dimensions

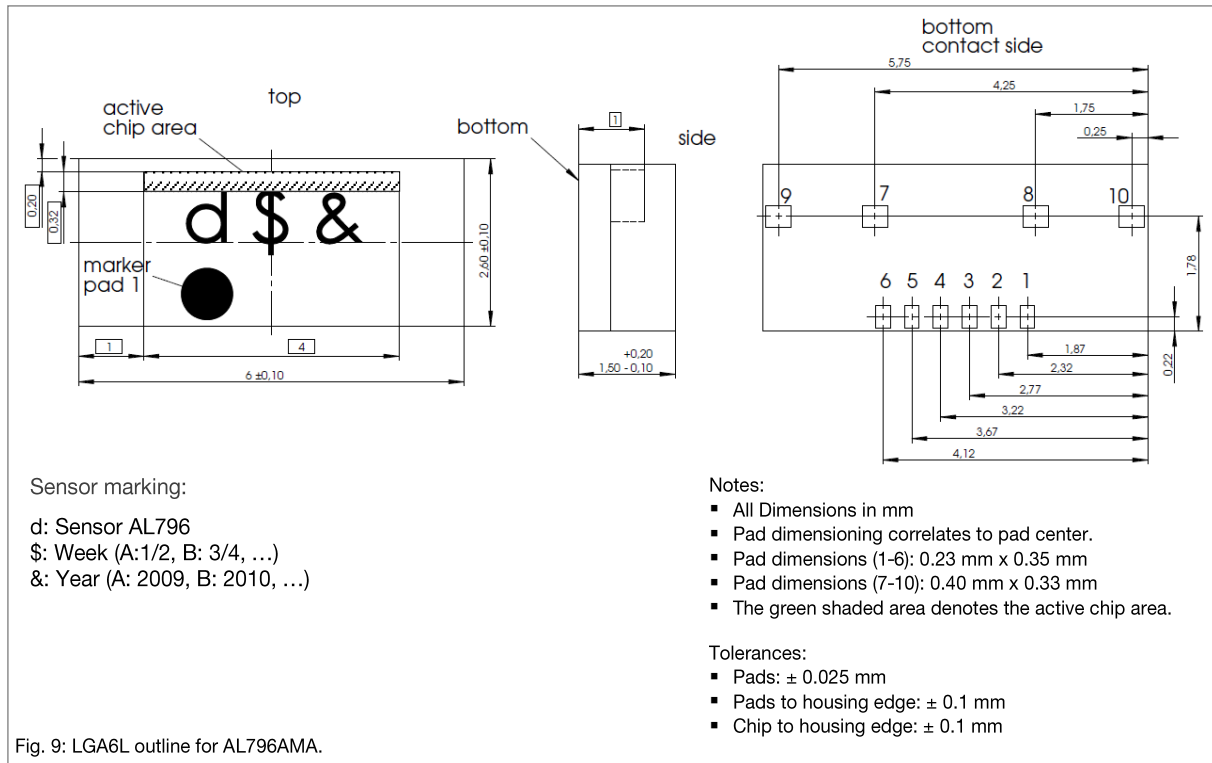

Fig. 9: LGA6L outline for AL796AMA.

AL796AMA LGA6L Package

Reel layout

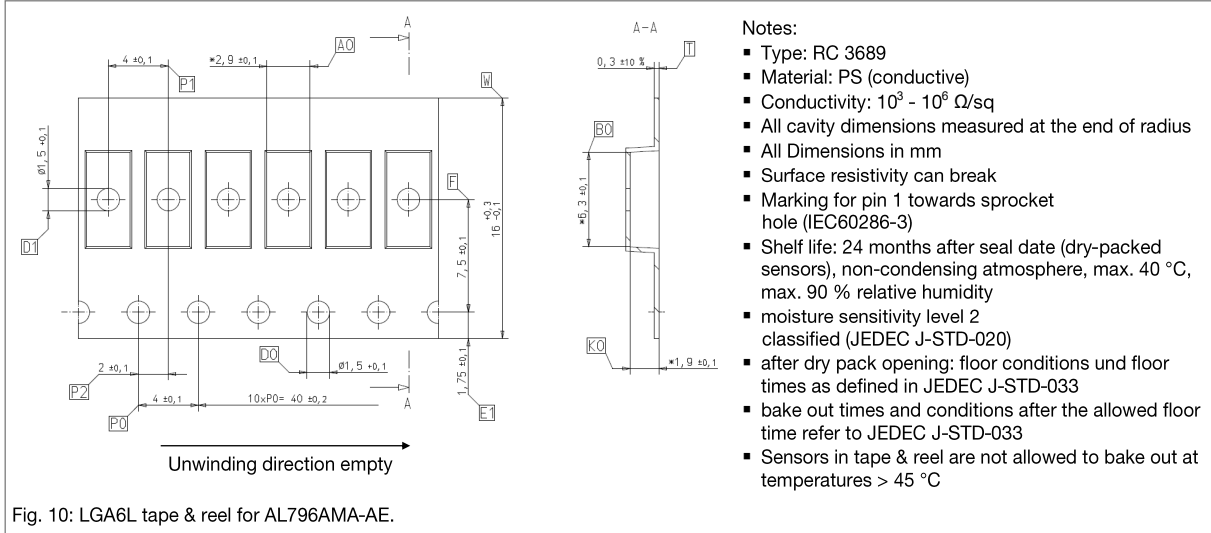

Fig. 10: LGA6L tape & reel for AL796AMA-AE.

Land pattern layout

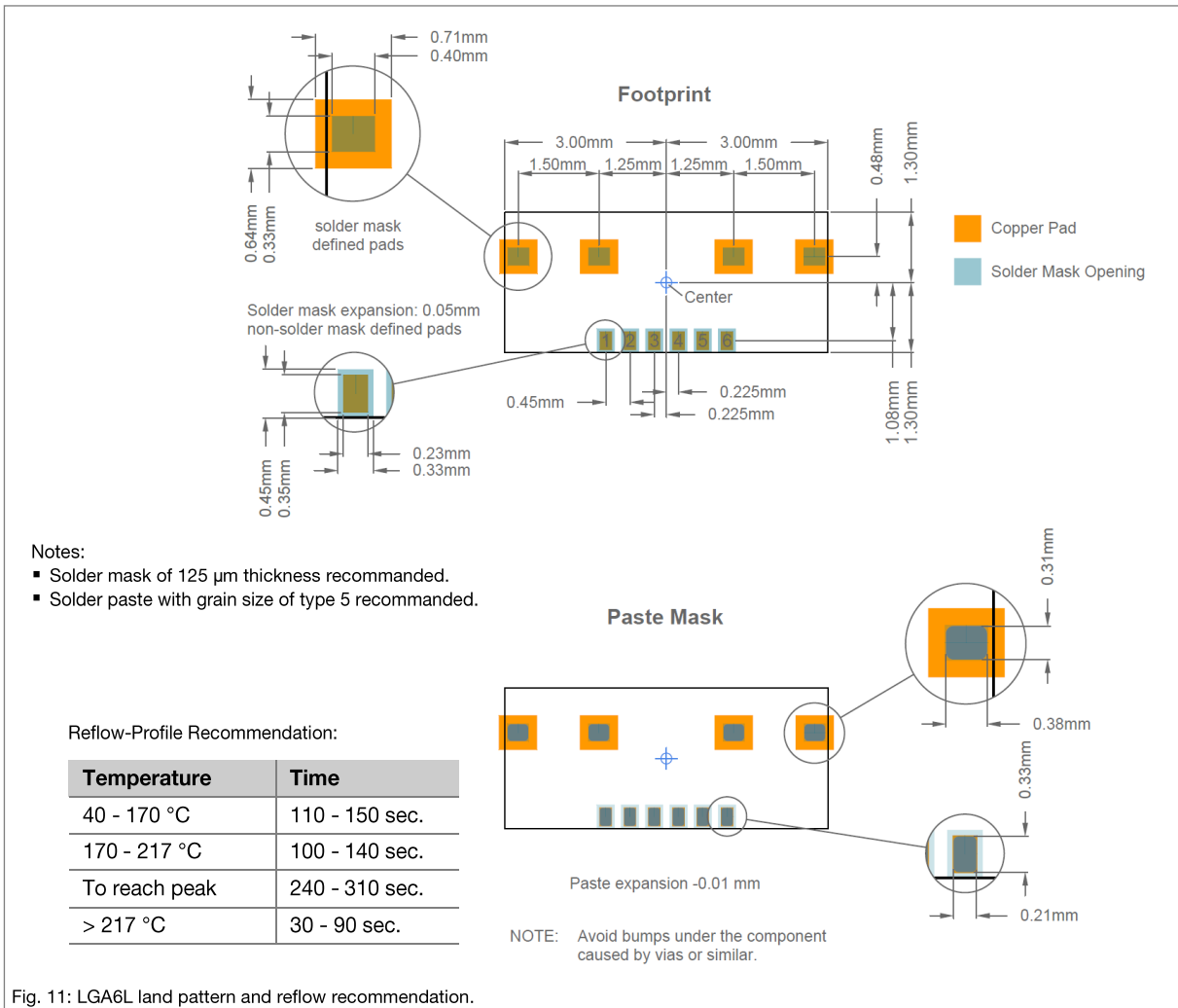

Fig. 11: LGA6L land pattern and reflow recommendation.

AL796AMS-AE SIL8 Package

Pinout

Pad	Symbol	Parameter
1	NC	Not connected
2	+V _{O1}	Positive output voltage bridge 1
3	+V _{O2}	Positive output voltage bridge 2
4	V _{CC}	Supply voltage
5	GND	Ground
6	-V _{O1}	Negative output voltage bridge 1
7	-V _{O2}	Negative output voltage bridge 2
8	NC	Not connected

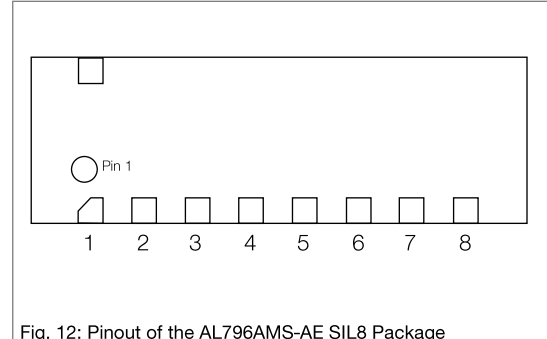

Fig. 12: Pinout of the AL796AMS-AE SIL8 Package

Dimensions

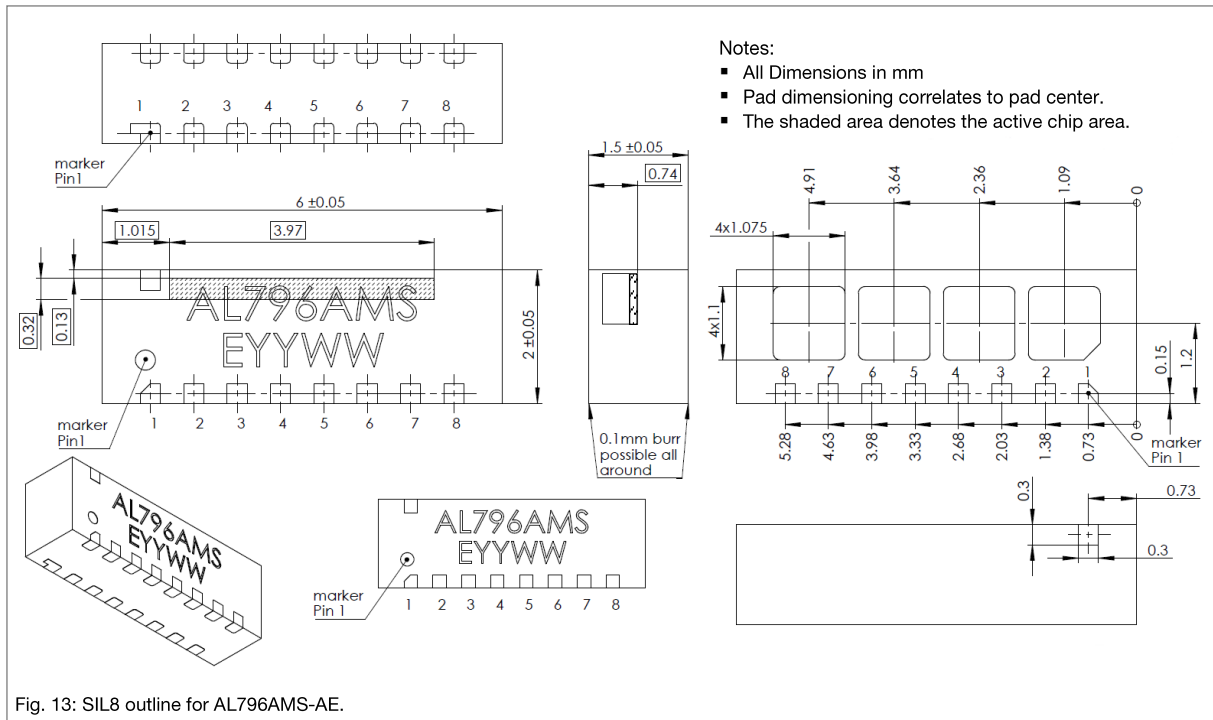

Fig. 13: SIL8 outline for AL796AMS-AE.

AL796AMS-AE SIL8 Package

Reel layout

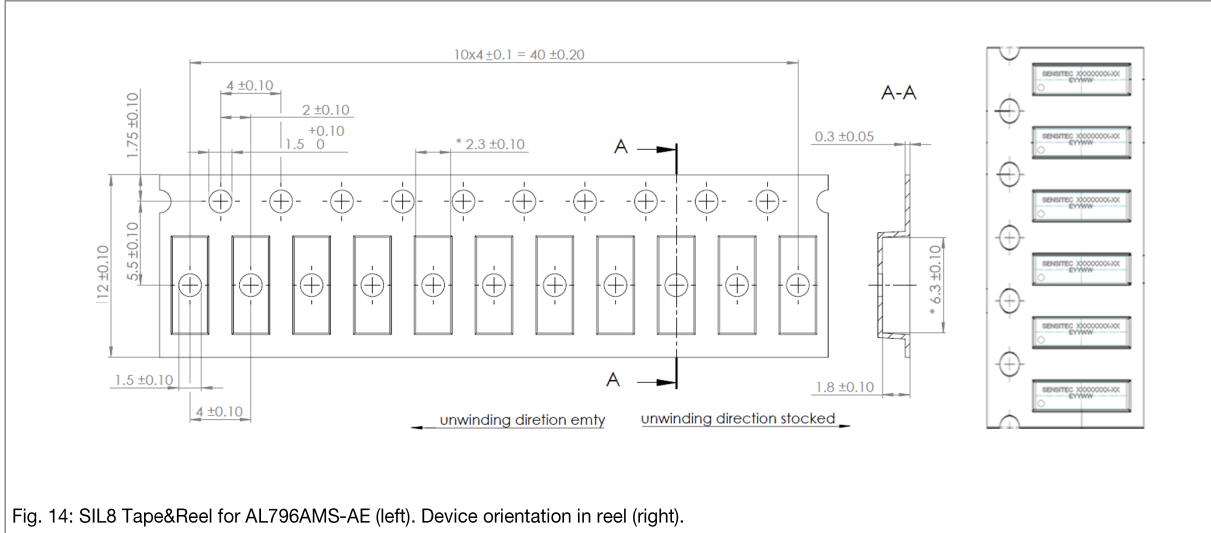

Fig. 14: SIL8 Tape&Reel for AL796AMS-AE (left). Device orientation in reel (right).

Land pattern layout

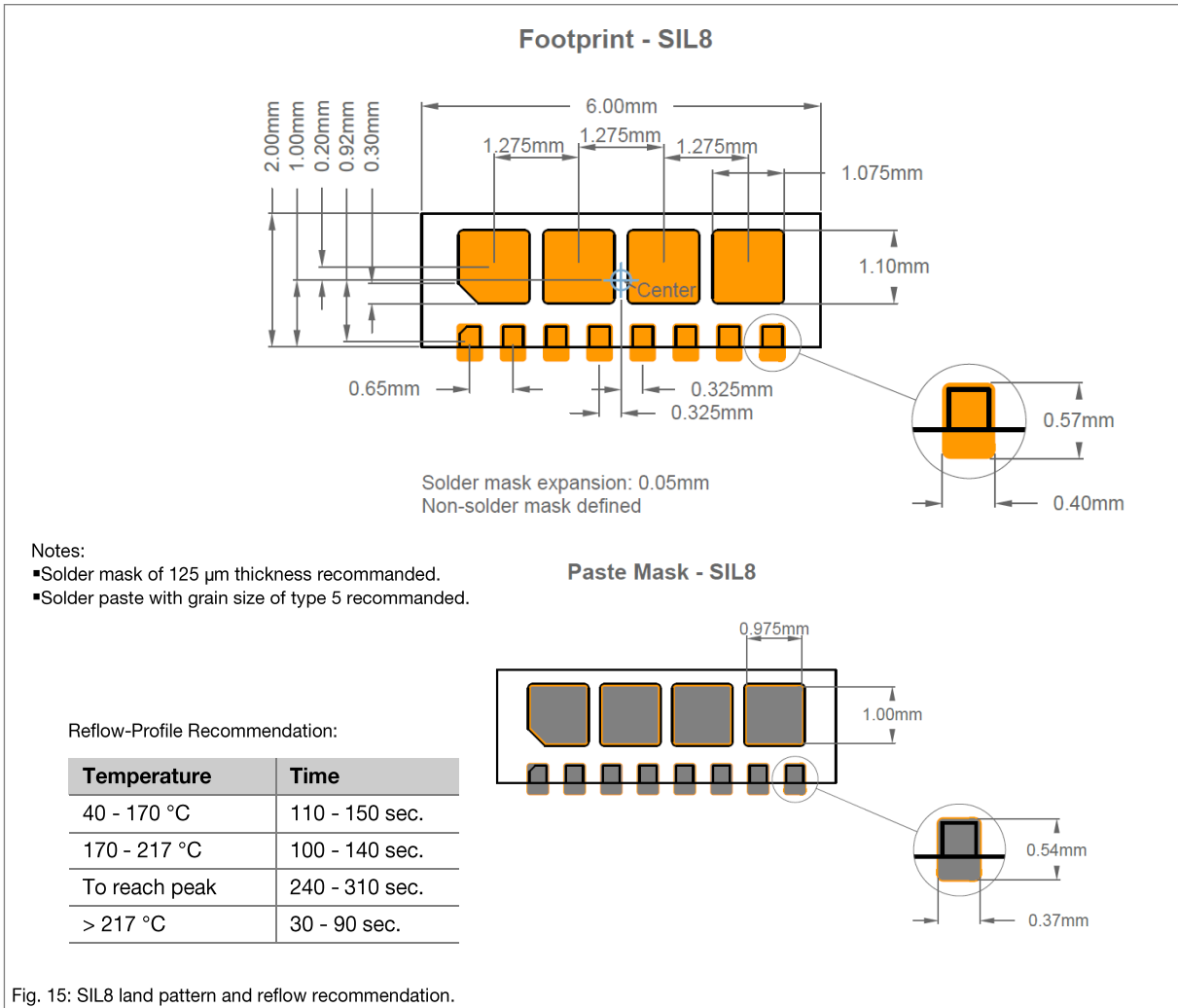
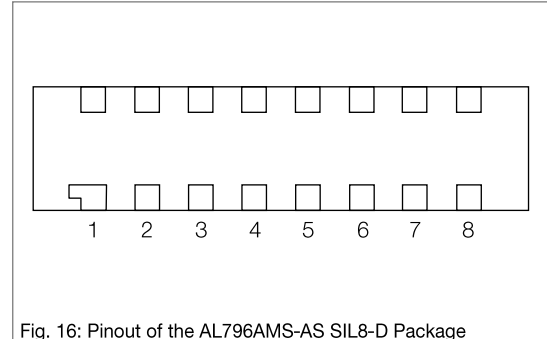

Fig. 15: SIL8 land pattern and reflow recommendation.

AL796AMS-AS SIL8-D Package

Pinout

Pad	Symbol	Parameter
1	NC	Not connected
2	+V _{O1}	Positive output voltage bridge 1
3	+V _{O2}	Positive output voltage bridge 2
4	V _{CC}	Supply voltage
5	GND	Ground
6	-V _{O1}	Negative output voltage bridge 1
7	-V _{O2}	Negative output voltage bridge 2
8	NC	Not connected



Dimensions

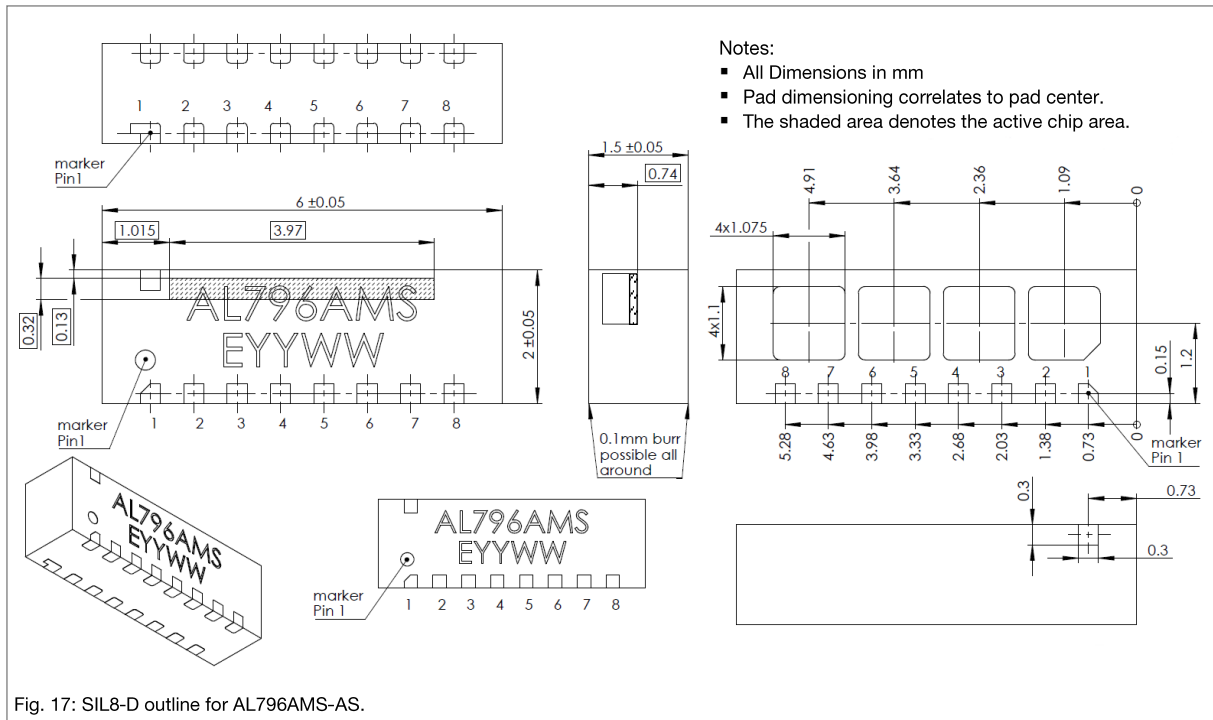

Fig. 17: SIL8-D outline for AL796AMS-AS.

AL796AMS-AS SIL8-D Package

Reel layout

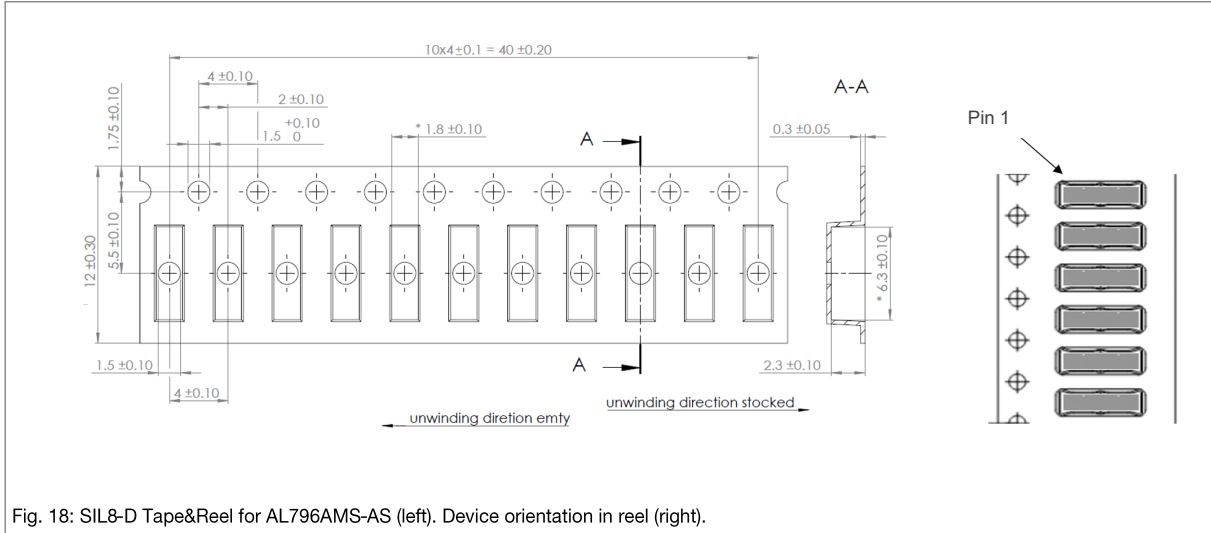

Fig. 18: SIL8-D Tape&Reel for AL796AMS-AS (left). Device orientation in reel (right).

Land pattern layout

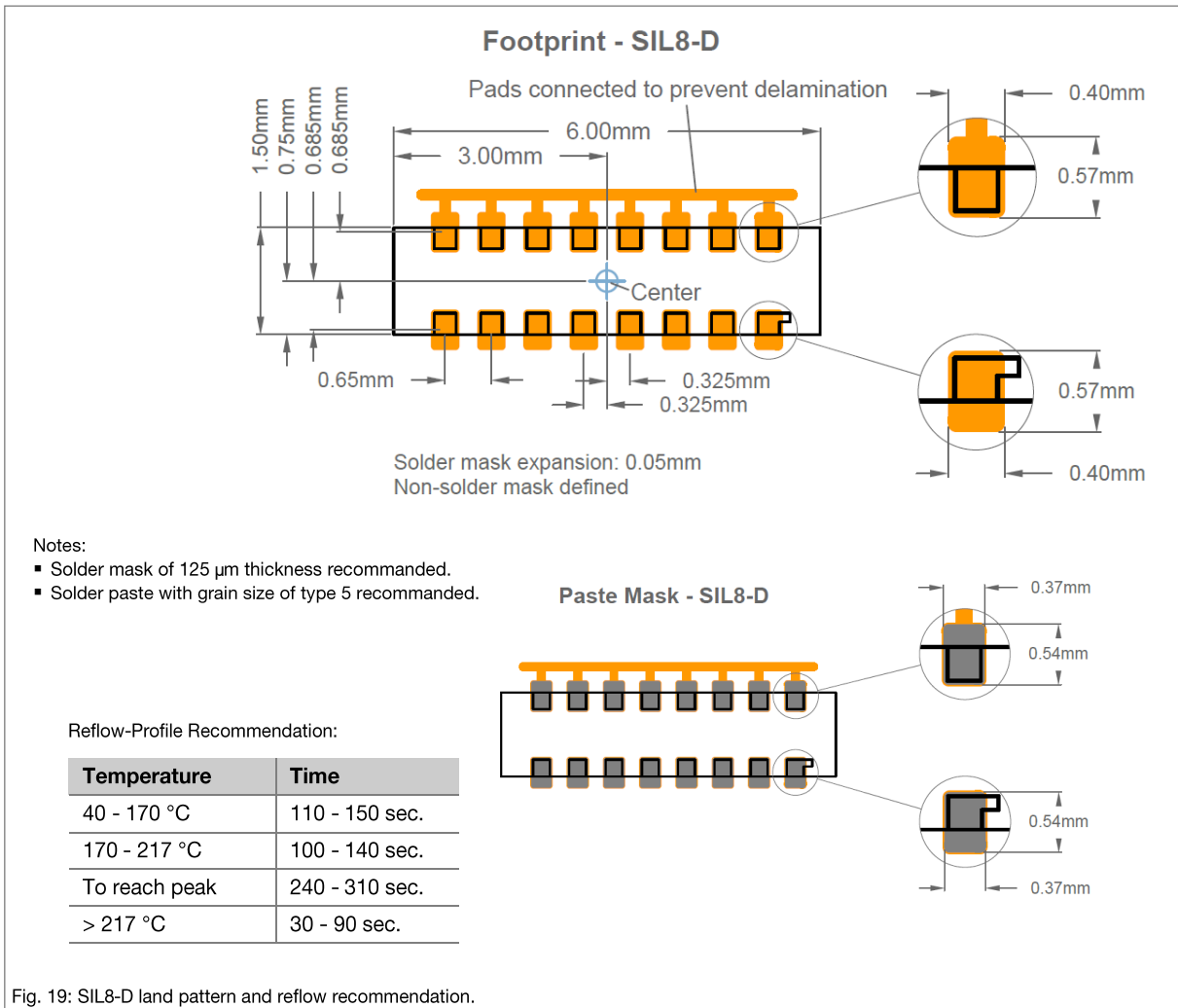
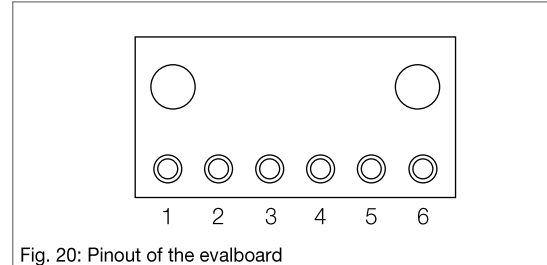

Fig. 19: SIL8-D land pattern and reflow recommendation.

Evalboard with AL796AMA-AE

Pinout

Pad	Symbol	Parameter
1	+V _{O1}	Positive output voltage bridge 1
2	+V _{O2}	Positive output voltage bridge 2
3	GND	Ground
4	V _{CC}	Supply voltage
5	-V _{O1}	Negative output voltage bridge 1
6	-V _{O2}	Negative output voltage bridge 2



Dimensions

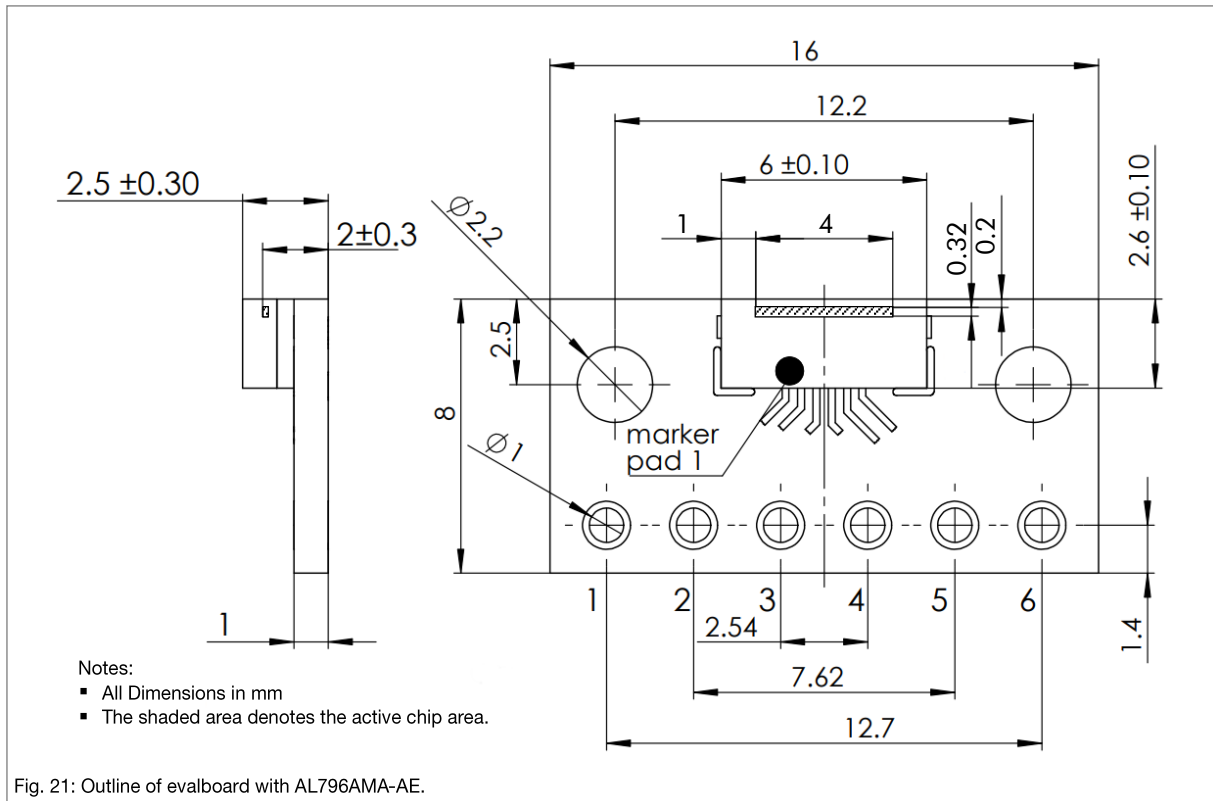

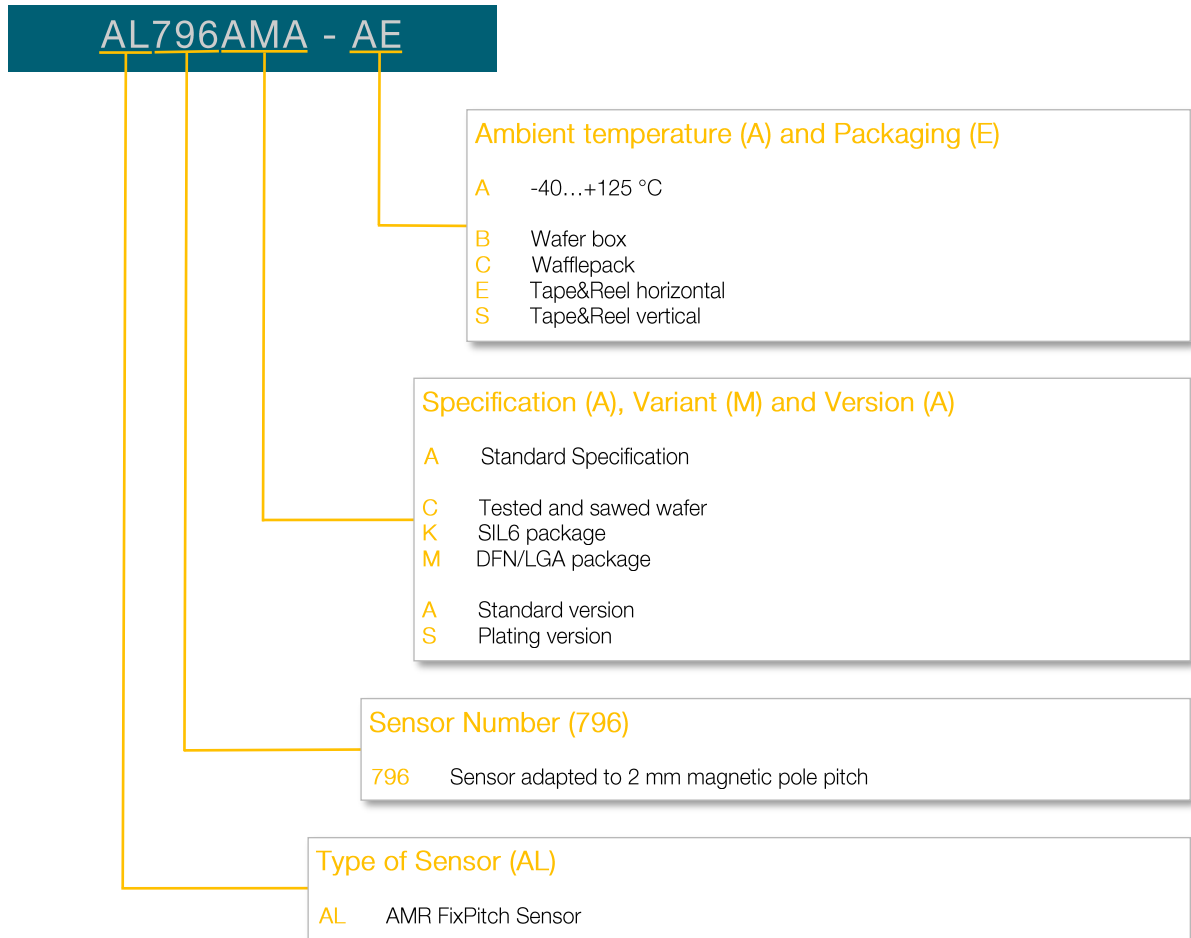
Additional Information on Ordering Code

Special Design Features

PerfectWave

Sensors with PerfectWave design provide the best signal quality, highest accuracy and optimal sensor linearity by filtering out higher harmonics in the signal. The linearity of the sensor is assured, even for weak magnetic field measurement.

PurePitch

In PurePitch sensors, the FixPitch principle is extended over several poles in order to increase accuracy still further. This arrangement reduces the influence of errors in the measurement scale and improves the immunity to interference fields.

FixPitch

FixPitch sensors are adapted to the pole length (pitch) of the measurement scale. The linearity of the sensor is optimized and the influence of interference fields is minimized.

General Information

Product Status

Article	Status
AL796ACA-AB	The product is in series production.
AL796ACA-AC	The product is in series production.
AL796AKA-AC	The product is in series production.
AL796AMA-AE	The product is in series production.
AL796AMS-AE	The product is under development, qualification is on going. Deliverables have a sample status. The datasheet is preliminary.
AL796AMS-AS	The product is under development, qualification is on going. Deliverables have a sample status. The datasheet is preliminary.
AL796 Evalboard	This product is for evaluation of the AL796AMA-AE sensor.
Note	The status of the product may have changed since this data sheet was published. The latest information is available on the internet at www.sensitec.com .

Disclaimer

Sensitec GmbH reserves the right to make changes, without notice, in the products, including software, described or contained herein in order to improve design and/or performance. Information in this document is believed to be accurate and reliable. However, Sensitec GmbH does not give any representations or warranties, expressed or implied, as to the accuracy or completeness of such information and shall have no liability for the consequences of use of such information. Sensitec GmbH takes no responsibility for the content in this document if provided by an information source outside of Sensitec products. In no event shall Sensitec GmbH be liable for any indirect, incidental, punitive, special or consequential damages (including but not limited to lost profits, lost savings, business interruption, costs related to the removal or replacement of any products or rework charges) irrespective the legal base the claims are based on, including but not limited to tort (including negligence), warranty, breach of contract, equity or any other legal theory. Notwithstanding any damages that customer might incur for any reason whatsoever, Sensitec product aggregate and cumulative liability towards customer for the products described herein shall be limited in accordance with the General Terms and Conditions of Sale of Sensitec GmbH. Nothing in this document may be interpreted or construed as an offer to sell products that is open for acceptance or the grant, conveyance or implication of any license under any copyrights, patents or other industrial or intellectual property rights. Unless otherwise agreed upon in an individual agreement Sensitec products sold are subject to the General Terms and Conditions of Sales as published at www.sensitec.com. The use and/or application of our products in a military end use is explicitly prohibited. In the event of infringements, we reserve the right to take legal action, including but not limited to the assertion of claims for damages and/or the immediate termination of the business relationship.

General Information

Application Information

Applications that are described herein for any of these products are for illustrative purposes only. Sensitec GmbH makes no representation or warranty – whether expressed or implied – that such applications will be suitable for the specified use without further testing or modification. Customers are responsible for the design and operation of their applications and products using Sensitec products, and Sensitec GmbH accepts no liability for any assistance with applications or customer product design. It is customer's sole responsibility to determine whether the Sensitec product is suitable and fit for the customer's applications and products planned, as well as for the planned application and use of customer's third party customer(s). Customers should provide appropriate design and operating safeguards to minimize the risks associated with their applications and products. Sensitec GmbH does not accept any liability related to any default, damage, costs or problem which is based on any weakness or default in the customer's applications or products, or the application or use by customer's third party customer(s). Customer is responsible for doing all necessary testing for the customer's applications and products using Sensitec products in order to avoid a default of the applications and the products or of the application or use by customer's third party customer(s). Sensitec does not accept any liability in this respect.

Life Critical Applications

These products are not qualified for use in life support appliances, aeronautical applications or devices or systems where malfunction of these products can reasonably be expected to result in personal injury.

Copyright © by Sensitec GmbH, Germany

All rights reserved. No part of this document may be copied or reproduced in any form or by any means without the prior written agreement of the copyright owner. The information in this document is subject to change without notice. Please observe that typical values cannot be guaranteed. Sensitec GmbH does not assume any liability for any consequence of its use.

Changelist

Version	Description of the Change	Date
AL796.DSE.18	Add evalboard information (p. 13)	11/2024
AL796.DSE.17	Layout improvements (pp. 1-15), Change technical drawing (p. 9, p. 11)	05/2024
AL796.DSE.16	Change technical drawing (p. 8, p. 9)/add footprint page SIL8 package (p. 10)	04/2024
AL796.DSE.15	Change product variant (p. 8, p. 9) / add order code page (p. 10)	08/2023
AL796.DSE.14	Disclaimer supplement	06/2022
AL796.DSE.00	Original (pp. 1-7)	04/2012

Sensitec GmbH

Schanzenfeldstr. 2 • 35578 Wetzlar • Germany
 Tel +49 (0) 6441 5291-0 • Fax +49 (0) 6441 5291-117
 sensitec@sensitec.com • www.sensitec.com